

11-6 Practice

Similar Triangles and Indirect Measurement

Write a proportion to find each missing measure x . Then find the value of x .

1.

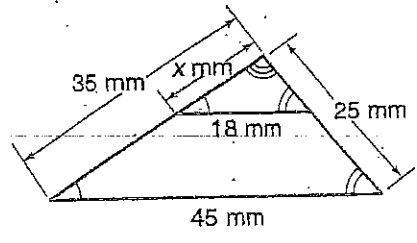

2.

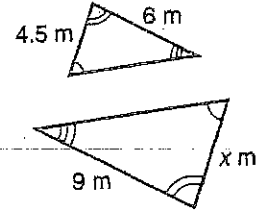

3.

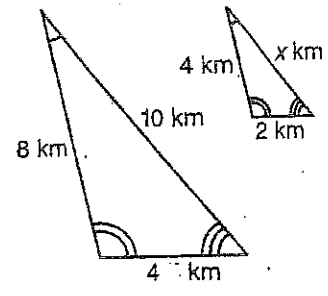

4.

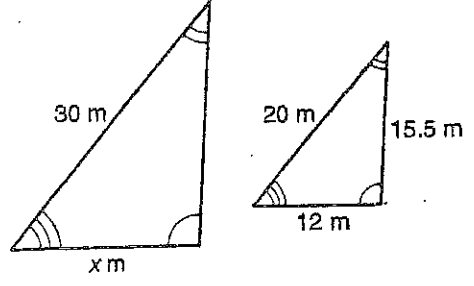

5.

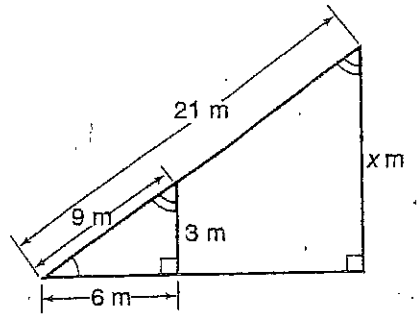

6.

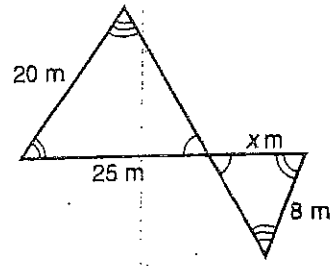

7.

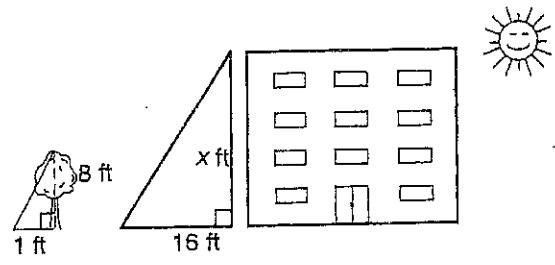

8.

